



APPLICATION HANDBOOK

HIGH PERFORMANCE CRANE ROPES



TOGETHER IN MOTION

CONTENT

SUCCESS THROUGH PERFECTION	4
TECHNOLOGIES FOR YOUR BENEFIT	5
1. PRODUCT INFORMATION	7
1.1 ROPES FOR MOBILE AND CRAWLER CRANES (EVOLUTION TK17)	7
1.2 ROPES FOR TOWER CRANES (EVOLUTION TK17, PERFECTION TK15)	8
1.3 ROPES FOR CIVIL ENGINEERING (QS 816 V, EVOLUTION TK16)	10
1.4 ROTATION RESISTANT ROPES (EVOLUTION TK16, EVOLUTION TK17 AND PERFECTION TK15)	14
1.5 NON ROTATION RESISTANT ROPES (QS 816 VG)	16
2. PURCHASING RECOMMENDATIONS	18
3. REQUIRED INFORMATION WHEN ORDERING A ROPE	20
4. STORAGE, HANDLING & INSPECTION	22
4.1 CERTIFICATION AND MARKING	23
4.2 UNLOADING WIRE ROPES UPON RECEIPT	23
4.3 INSPECTING WIRE ROPES UPON RECEIPT	24
4.4 STORAGE	25
4.5 UNCOILING/UNWINDING	26
5. WIRE ROPE INSTALLATION	29
5.1 FIRST TIME INSTALLATION	30
5.2 REPLACEMENT INSTALLATION	30
5.3 CUTTING OF A ROPE	31
5.4 REEVING	32
5.5 CHOICE OF ROPE LAY DIRECTION IN MULTI-LAYER APPLICATION	32
5.6 MULTI-LAYER SPOOLING	34
5.7 RECOMMENDATION FOR OPTIMAL SPOOLING OF ROPES IN MULTI-LAYER APPLICATION ON PLAIN BARRELED DRUMS	35
5.8 RECOMMENDATION: ROPE INSTALLATION ON MULTI-LAYER DRUMS FOR LUFFING ROPES	36
5.9 AFTER FINISHING INSTALLATION	37

CONTENT

■	6. ROPES IN OPERATION	38
	6.1 GENERAL	38
	6.2 INSPECTING THE ROPE CONVEYING SYSTEM	38
	6.3 SHEAVES AND DRUMS	39
	6.4 ACTUAL ROPE DIAMETER	41
	6.5 END TERMINATION	41
	6.6 DOCUMENTATION	41
	6.7 INSPECTION OF LEBUS GROOVED DRUMS FOR MULTI-LAYER SPOOLING	44
	6.8 TWISTING OF SHEAVE BLOCK	45
	6.9 UNTWISTING OF HOISTING ROPE	46
	6.10 USING OF SWIVEL	46
■	7. WIRE ROPE MAINTENANCE (GENERAL)	48
	7.1 CLEANING OF WIRE ROPES	48
	7.2 WIRE ROPE LUBRICATION	48
	7.3 RE-LUBRICATION	50
	7.4 REMOVAL OF BROKEN WIRE ENDS	51
	7.5 SLIP AND CUT (PROCESS)	51
	7.6 ADDITIONAL TROUBLE-SHOOTING FOR EXPERIENCED STAFF	52
	7.7 WARNINGS	53
■	8. DISCARD CRITERIA	55
■	9. CHECKLIST FOR OPTIMAL MULTI-LAYER SPOOLING	65

WARNING

The use of these products can be hazardous. Therefore, never use our products for purposes other than those they were designed for. Customers must ensure that all persons using these products are familiar with their correct use and the related necessary safety precautions. Please bear in mind that any of these products can cause harm, when they are used incorrectly or overstrained.

SUPERFILL® and PLASTIFILL™ are registered trademarks of TEUFELBERGER Ges.m.b.H. TEUFELBERGER and 拖飞宝 are internationally registered trademarks of TEUFELBERGER Ges.m.b.H. Austria.

SUCCESS THROUGH PERFECTION

TEUFELBERGER Seil Ges.m.b.H. fully concentrates on high-performance steel wire ropes in all aspects of production, research & development, marketing & sales activities: top quality products are the basis of our success.

We care more for our customers – this is the mission of the TEUFELBERGER Seil Ges.m.b.H. Close cooperation with our suppliers, joint development work with OEMs and highly qualified staff ensure that our products fulfill your requirements 100%.

Two production sites with modern machinery, an own research and development department along in close cooperation with our subsidiaries ensure that our know-how is transferred optimally into your success. From the petroleum industry to harbors, from building sites and forestry to ropeways for passengers and goods – TEUFELBERGER's high-performance steel wire ropes and systems for personal safety are perfectly tailored to fit your field of application.

The power of innovation and quality awareness for the benefit of our customers.

Long-term cooperation with universities and research institutions and with numerous key users in the aftermarket stands for our focus on customer requirements. We give research & development top priority, which is reflected in a decentralized company structure to exploit synergies. Our quality awareness is evident by fulfilling ISO 9001 as well as compliance with industry-specific standards.

Service hotline

In case of any urgent problems, you can reach TEUFELBERGER Wire Rope as follows:
24 h hotline: +43 (0) 7242-615-388

PERFECT WORDWIDE SERVICE

- 24 hours 365 days availability of service engineers
- Specific training for maintenance people, training on the job (i.e. Sedco 702)
- Joint installation for training purposes
- Free installation manual

TECHNOLOGIES FOR YOUR BENEFIT

Our know-how provides essential advantages in use and effective cost savings. Our high-performance steel wire ropes achieve an outstanding service life, provide best possible safety for persons and devices and reduce maintenance, replacement and organization costs.

PLASTFILL™ INSERT

The lubricated steel core is enclosed in a tight synthetic coat.

Advantages: long service life through permanent lubrication, resistance against radial pressure and lateral pressure, higher breaking forces through reduced stresses in the rope.

The strands are embedded in the synthetic coat during the closing process.

Advantages: exact strand position with consistent clearances for reduced internal abrasion, equal load shares at all components due to optimized construction.

SUPERFILL® COMPACTION TECHNOLOGY

Our compaction method has been developed in close cooperation with universities and independent research institutions. Each rope strand is compacted in a specific procedure with the aim of significantly improving the rope's properties:

- up to 30% more breaking forces than non-compacted ropes
- prolonged service life due to reduced internal stress
- use of smaller rope diameters with the same breaking load (important for new crane constructions)
- smooth rope surface resulting in reduced abrasion on rope, sheaves and drums
- a continuous constant wire rope diameter for long lengths

GALVANIZED STEEL WIRES

Our steel wires are galvanized before they are drawn in order to achieve high wire precision. This ensures optimal stability and service life. Galvanization in combination with our PLASTFILL™ technology provides for extreme resistance against corrosion.

TECHNOLOGIES FOR YOUR BENEFIT

ADVANTAGES OF TEUFELBERGER HIGH-PERFORMANCE ROPE DESIGN

The name **TEUFELBERGER** represents a solid corporate group with 3 strategic business divisions and more than 200 years of experience. The company is family-owned. More than 750 dedicated employees achieve an export performance of more than 80% of total turnover per year. **TEUFELBERGER Seil Ges.m.b.H.** concentrates exclusively on the manufacturing, research & development, marketing and sale of high-performance steel wire ropes.

KNOW-HOW AND EXPERIENCE IN THE INDUSTRY:

- Manufacturing of steel wire ropes for more than 80 years
- Successful long term relationship with satisfied key customers in the construction industry. Development of partnership with well known OEM's e.g. Liebherr, Bauer, Casagrande, IMT

ADVANCED RESEARCH AND DEVELOPMENT:

- High and ongoing investments in our product development and continuous improvement of the manufacturing process in order to provide best material for the end user.
- New ultra-modern winch test stands and bending fatigue machines in order to get accurate and realistic test results which we use to develop new designs.
- R&D partnerships between the other strategic business divisions promise ongoing developments in the steel wire rope sector.

MATERIAL – REDUCED RISK OF CORROSION:

- **TEUFELBERGER** exclusively uses top-strength materials and highly modern production processes in order to fulfill customer requirements.
- Use of real "hydrophobic" polypropylene **PLASTFILL™** material for best protection of the core and providing permanent lubrication

TECHNOLOGIES:

- A combination of **PLASTFILL™** plasticized steel core, **SUPERFILL®** strand compacted ropes and **DRAWN GALVANIZED** wires provides the best service life for our end user.

TEUFELBERGER ropes provide

- Highest reliability
- Highest safety standards
- Reduction of total cost of ownership through highest possible fatigue life
- Worldwide availability

1. PRODUCT INFORMATION

1.1 ROPES FOR MOBILE AND CRAWLER CRANES (EVOLUTION TK17)

The capacity of mobile cranes continues to increase. In this context, the focus clearly is on greater flexibility, the handling of even heavier loads, and on boosting performance. TEUFELBERGER makes high-performance hoisting ropes featuring highest breaking forces and perfectly suited for multi-layer winding.

TRUCK-MOUNTED AND CRAWLER CRANES

Non-rotating lang's lay ropes used as hoisting ropes:

■ **EVOLUTION TK17*** featuring SUPERFILL® compaction technology, suited for extreme lifting heights and high loads

■ **PERFECTION TK15*** with inner rope in SUPERFILL® compaction technology

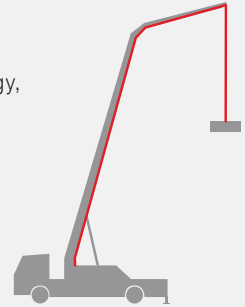

EVOLUTION TK17

MULTI-LAYER WINDING

Regular lay (also available as Lang's lay version)

10 – 34 mm: 16 x K6-PIWRC (K), RCN 23-2

Rope grade: 1770 / 1960 / 2160

Number of wires in outer strands: 112

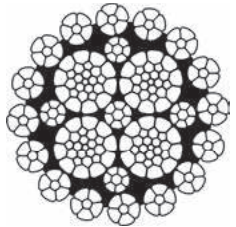

SUPERFILL® PLASTIFILL™

* Lang's lay ropes may be used with multi-layer winding (on the drum) only, or they must be subjected to periodical, non-destructive checks.

1. PRODUCT INFORMATION

1.2 ROPES FOR TOWER CRANES (EVOLUTION TK17, PERFECTION TK15)

Safety and reliability are vital characteristics for ropes used in building construction. The trend toward utilizing equipment at the limits of its capacity leads to unexpected downtimes caused by rope problems and, as a consequence, generates extra costs. 24 hours a day, 365 days a year, TEUFELBERGER ropes stand the test around the globe on tower cranes of industry-leading manufacturers.

TOWER CRANES

■ **EVOLUTION TK17*** rotation-resistant lang's lay rope featuring SUPERFILL® compaction technology, suited for hoisting to extreme heights and high loads

■ **PERFECTION TK15*** rotation-resistant regular lay or lang's lay design, specifically suited for hoisting to great heights

■ **612 W** 6-strand regular lay rope; suited for use as trolley rope and mounting rope

■ **QS 816 V** 8-strand regular lay rope, suited as guyline, stay rope, and as mounting rope

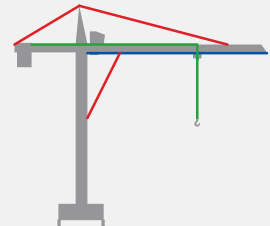

1. PRODUCT INFORMATION

PERFECTION TK15

MULTI-LAYER WINDING

Ordinary and lang's lay, right or left lay
7 – 24 mm: 16 x 7-IWRC (K), RCN 23-2
Rope grades: 1770 / 1960 / 2160
Number of wires in the outer strands: 112



SUPERFILL®

PLASTIFILL™

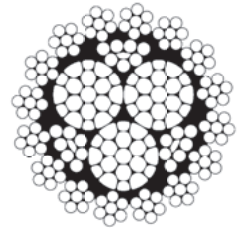

EVOLUTION TK17

(see page 7)

* Lang's lay ropes may be used with multi-layer winding (on the drum) only, or they must be subjected to periodical, non-destructive checks.

1. PRODUCT INFORMATION

1.3 ROPES FOR CIVIL ENGINEERING (QS 816 V, EVOLUTION TK16)

For a top-level performance, various applications of relevance to civil engineering such as drilling, trench-cutting, grabbing, or pile-driving require rope types tailored to the specific purpose. Especially in the field of civil engineering, TEUFELBERGER brings long-standing experience obtained by cooperating with leading equipment manufacturers and prestigious end customers.

BORED PILE GRAB

■ **EVOLUTION TK16** rotation-resistant regular lay rope, suited for use as hoisting rope and closing rope

■ **QS 816 V** 8-strand regular lay rope, suited for use as stay rope and boom stay rope (neck rope)

■ **QS 816 V(G)*** 8-strand regular lay or lang's lay rope suited for use as luffing rope

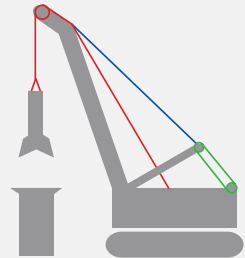

DIAPHRAGM WALL GRAB

■ **QS 816 V** – 8-strand regular lay rope, suited for use as stay rope and boom stay rope (neck rope)

■ ■ **QS 816 V(G)*** 8-strand regular lay or lang's lay rope, suited for use as luffing rope, hoisting rope, and hoisting/closing rope

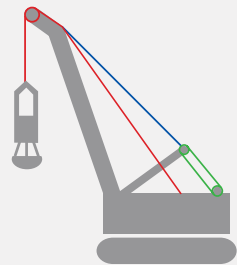

* Lang's lay ropes may be used with multi-layer winding (on the drum) only, or they must be subjected to periodical, non-destructive checks.

CABLE DREDGER

■ **EVOLUTION TK 16*** – rotation-resistant regular lay or lang's lay rope, suited for use as hoisting rope

■ **QS 816 V** – 8-strand regular lay rope, suited for use as stay rope and boom stay rope (neck rope)

■ **QS 816 V(G)*** – 8-strand regular lay or lang's lay rope, suited for use as luffing rope

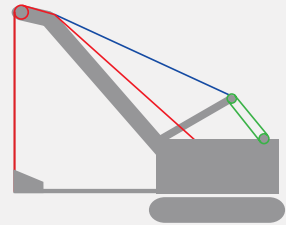
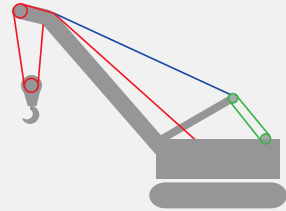

SLURRY TRENCH CUTTER

■ **EVOLUTION TK 16*** – rotation-resistant regular lay or lang's lay rope, suited for use as hoisting rope

■ **PERFECTION TK 15*** – rotation-resistant regular lay and lang's lay rope, suited for use as hoisting rope

■ **QS 816 V** – 8-strand regular lay rope, suited for use as stay rope and luffing rope (neck rope)

■ **QS 816 V(G)*** – 8-strand regular lay or lang's lay rope suited for use as luffing rope

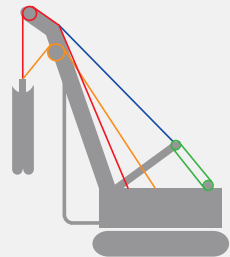

* Lang's lay ropes may be used with multi-layer winding (on the drum) only, or they must be subjected to periodical, non-destructive checks.

1. PRODUCT INFORMATION

ROTARY DRILLING RIG

■ **EVOLUTION TK 16*** – rotation-resistant regular lay or lang's lay rope, suited for use as hoisting rope

■ **PERFECTION TK 15** – rotation-resistant regular lay rope, specifically suited for use as hoisting rope and auxiliary hoisting rope

■ **QS 816 V** – 8-strand regular lay rope suited for use as stay rope and boom stay rope (neck rope)

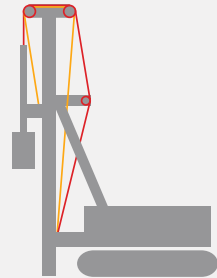

PILE DRIVER

■ **EVOLUTION TK 16** – rotation-resistant regular lay rope suited for use as hoisting rope

■ **PERFECTION TK 15*** – rotation-resistant regular lay and lang's lay rope suited for use as hoisting rope and auxiliary hoisting rope

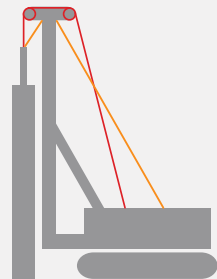

* Lang's lay ropes may be used with multi-layer winding (on the drum) only, or they must be subjected to periodical, non-destructive checks.

1. PRODUCT INFORMATION

QS 816 V

MULTI-LAYER WINDING

QS 816 V in ordinary lay, left and right lay

10 – 42 mm: 8 x K26WS-EPIWRC (K), RCN 09

44 – 50 mm: 8 x K31WS-EPIWRC (K), RCN 11

Rope grades: 1770 / 1960 / 2160

Number of wires in the outer strands: 208 (10 – 42 mm)

248 (44 – 50 mm)

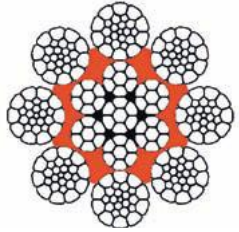

SUPERFILL®

PLASTIFILL™

EVOLUTION TK16

MULTI-LAYER WINDING

Ordinary lay (also available in langs lay), right or left lay

8 – 30 mm: 16 x K6-EPIWRC (K), RCN 23-1

32 – 42 mm: 16 x K7-EPIWRC (K), RCN 23-2

Rope grades: 1770 / 1960 / 2160

Number of wires in the outer strands: 96 (8 – 30 mm)

112 (32 – 42 mm)

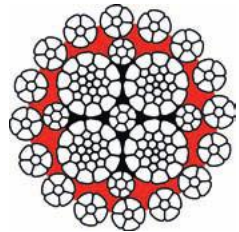



SUPERFILL®

PLASTIFILL™

1. PRODUCT INFORMATION

1.4 ROTATION RESISTANT ROPES (EVOLUTION TK16, EVOLUTION TK17 AND PERFECTION TK15)

Rope Designation	RCN**	Diameter	Description	SUPERFILL®		PLAST-FILL™
				inside	outside	
 <p>EVOLUTION EVOLUTION TK16*</p>	23-1 23-2	8-30 mm 32-42 mm	One of the best hoisting ropes with great breaking forces and high flexibility!	<input checked="" type="checkbox"/>	<input checked="" type="checkbox"/>	<input checked="" type="checkbox"/>
 <p>EVOLUTION EVOLUTION TK17*</p>	23-2	10-34 mm	Top hoisting rope without PLASTFILL™ insert for maximum flexibility	<input checked="" type="checkbox"/>	<input checked="" type="checkbox"/>	<input type="checkbox"/>
 <p>PERFECTION PERFECTION TK15*</p>	23-2	7-24 mm	High minimum breaking forces, increased service life, and optimal rotating behavior – especially with large lifting heights	<input checked="" type="checkbox"/>	<input type="checkbox"/>	<input type="checkbox"/>



hoisting rope



hauling rope



trolley rope



luffing rope



auxiliary hoisting rope



guy and stay rope



closing rope



pull-on/mounting rope















1. PRODUCT INFORMATION



Truck-mounted
and crawler cranes

Tower cranes

Gantry cranes, bridge
cranes, and industrial
installations

 preferred choice

 alternative choice

* Lays lay ropes may be used with multi-layer winding (on the drum) only, or they must be subjected to periodical non-destructive checks.

** acc. ISO 4309

NOTE!

Our rope recommendations are non-binding empirical values. Please be sure to take the special characteristics of your installation into account. Do not hesitate to contact us. We will help you find the best possible rope solution for your needs.

1. PRODUCT INFORMATION

1.5 NON ROTATION RESISTANT ROPES (QS 816 VG)

Rope Designation	RCN	Diameter	Description	SUPERFILL®		PLAST-FILL™
				inside	outside	
 EVOLUTION QS 816 V(G)*	09	10-42 mm	Best bending-cycle performance and high form stability to lateral pressure: therefore, best performance in multilayer winding applications	<input checked="" type="checkbox"/>	<input checked="" type="checkbox"/>	<input checked="" type="checkbox"/>
	11	44-50 mm				



hoisting rope



luffing rope



closing rope



hauling rope



auxiliary hoisting rope



pull-on/mounting rope



trolley rope



guy and stay rope

1. PRODUCT INFORMATION

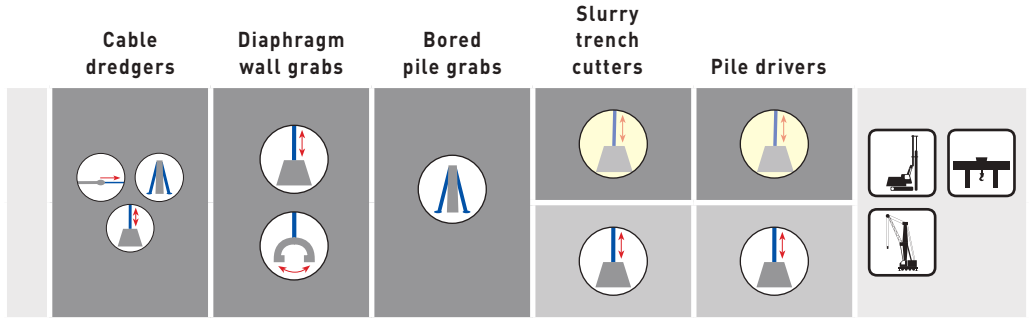

preferred choice



alternative choice

* Langs lay ropes may be used with multi-layer winding (on the drum) only, or they must be subjected to periodical non-destructive checks.

NOTE!

Our rope recommendations are non-binding empirical values. Please be sure to take the special characteristics of your installation into account. Do not hesitate to contact us. We will help you find the best possible rope solution for your needs.

2. PURCHASING RECOMMENDATIONS

Based on many years of experience, resulting from close co-operation with leading crane manufacturers and customers using high-performance wire ropes, the following points should be considered when selecting a wire rope:

ALWAYS COMPARE APPLES WITH APPLES

Especially consider rope characteristics like breaking force, galvanization, plasticized steel core, expected lifetime and general quality factors which influence the rope performance.

CONSIDER THE MINIMUM BREAKING FORCE AS THE KEY SELECTION CRITERION

The minimum breaking force of a rope has to reach the level specified for a special crane as shown in the crane specification document. The use of a rope with less than the specified minimum breaking force is not allowed and may have serious consequences!

LEFT OR RIGHT LAY

The lay of a rope is crucial for the performance and the lifetime of a wire rope. The correct lay can also be found in the crane specification document. If you are not sure which lay is needed, you can also contact our technical experts.

LANG'S LAY OR ORDINARY LAY

Ordinary lay normally can be used for most applications. To allow the use of a lang's lay rope, this must be specified in the crane specification document. Ropes in lang's lay can reach a longer service life under certain circumstances. Lang's lay ropes must not be used in single layer spooling and/or just on plastic sheaves.

CHECK CROSS REFERENCE

TEUFELBERGER can offer alternative special wire ropes for most rope types available on the market. To select a proper rope type, please specify the original rope type. Our rope experts will then select a rope that will reach the performance of the mentioned rope in any case.

CHECK METRICS (SIZE CONVERSION)

Be careful when converting the imperial into metric size, especially in case you require e.g. a 1" rope. We offer tailor made ropes in imperial sizes.

2. PURCHASING RECOMMENDATIONS

USE OF GALVANIZED ROPES

Galvanized ropes can be used in any case and can always replace ungalvanized (bright) ropes. The opposite way – replacing galvanized with ungalvanized ropes – is not recommended and may even be dangerous under certain circumstances, as the rope loses the positive effect of galvanization (higher corrosion resistance leading to a longer service life, especially in maritime environments).

CHECK ENVIRONMENTAL CONDITIONS

Factors like humidity, salt water, dust & dirt require a special protection of the inner core. Therefore, a plasticized steel core is a major merit in relation to service & overall lifetime.

END TERMINATION

Please check which kind of end termination, if any, is necessary for a specific rope. This information has to be provided when placing an order. Please consider loss of efficiency for certain end terminations.

CERTIFICATES

Please check and specify when placing an order, which certificates are required. TEUFELBERGER provides ABS, DNV, LRS, GL etc.

3. REQUIRED INFORMATION WHEN ORDERING A ROPE

BASIC TECHNICAL INFORMATION

- **Customer** (end user, rig name)
- **Application**
- **Nominal rope diameter** (mm or inch)
- **Diameter tolerance** (if applicable)
- **Nominal rope length** (m or feet)
- **Length tolerance** (if applicable)
- **Construction** (brand and name)
- **Type of core**
- **Rope Grade**
- **Finish** – ungalvanized / galvanized
- **Type of lay**
- **Type of lubrication**
- **Required minimum breaking force**
- **Rope standard**
- **Manufacturing standard** (ISO, EN, API)
- Reel specification (TK 18 only steel reels)
- **Back tension required when spooling onto winch?**
- **Termination inner end**
- **Termination outer end** (TEUFELBERGER Pull-eye or tailor made solution)
- **Certification** – third party authority (if required)
- **Gross weight** (incl. termination, reel etc.)
- ID-number (if required)

Bold lettered informations are “must” information

ADDITIONAL INFORMATION

- Crane manufacturer – crane type
- Drum details – grooved: Yes or No
If yes: Helical or Lebus
Pitch of grooving: Width of drum (mm)
- Sheave/drum to wire rope diameter (D/d ratio)
- Number of wraps per layer
- Number of layers
- Operation climate: (high/low temperatures)



4. STORAGE, HANDLING & INSPECTION

ATTENTION: Instructions and warnings (standard warning)

As a provider of ropes with many years of experience, our rope recommendations are nonbinding but based on experience. Please note the special characteristics of your system. Contact us to find the optimal rope for you, based on the latest experience. Typing and printing errors excepted. Lang's lay ropes must be used for multiple layer winding (on the drum) or must be subjected to regular, non-destructive inspection.

Handling & installation of the rope should be carried out in accordance with a detailed plan and should be supervised by a competent person.

WARNING

Incorrectly supervised handling and installation procedures may result in serious injury to persons in the working area of installation and as well as those persons directly involved in the handling and installation.

General notes

The following notes and warnings are intended to ensure safe handling. Non-compliance may cause damage and hazard.

Warnings refer to potential hazards that may reduce the rope quality, thus endangering personnel and damaging rope-related equipment.

4. STORAGE, HANDLING & INSPECTION

4.1 CERTIFICATON AND MARKING

Ensure that the correct rope has been supplied by checking that the description on the Certificate is in accordance with that specified on the purchase order. Make sure that you take the relevant certificate from the delivered drum before using the rope. (We refer to statutory requirements.)

Verify that the marking on the rope or its package matches the relevant certificate. Retain the certificate in a safe place for identification of the rope when carrying out subsequent periodic statutory examinations in service. (We refer to statutory requirements).

 **NOTE**

The rating of a component of a machine or lifting accessory is within the responsibility of the designer of the machine or accessory. Any re-rating of a lifting accessory must be approved by a competent person. (See ISO 4309.)

4.2 UNLOADING WIRE ROPES UPON RECEIPT

Check the rope packaging for any transport damage.

Record any such damage on the delivery note.

When unloading, take appropriate measures to avoid damage to the rope.

In particular, take care not to damage the rope with the forks of the lift truck.

To avoid damage when lifting coils or reels, webbing slings are recommended.

Reels are preferably lifted by using a shaft inserted through the center hole.

4. STORAGE, HANDLING & INSPECTION

4.3 INSPECTING WIRE ROPES UPON RECEIPT

CHECK MARKING & CERTIFICATION

If not properly marked, coils or reels must be labeled immediately according to the delivery note to avoid subsequent confusion. Accompanying quality certificates must be checked against the purchase order specifications and against the marking on the reel. Make sure that the certificates are kept in a safe dry place.

CHECK ROPE PARAMETERS

Make sure that the rope delivered meets the purchasing specification, especially in terms of

- rope diameter
- lay direction
- MBF
- end termination
- ropes construction

To measure the rope diameter, two different sets of measurements are taken, spaced at a minimum distance of one meter, and in two different planes perpendicular to each other. The measuring calipers (available from TEUFELBERGER) have to be sufficiently wide. The rope diameter is the average of these four measurements. (For measuring method see DIN or CE rope standards.) The wire rope diameter should be within the tolerance specified in the purchase order. It has to be checked if there is a different tolerance in the rope handling system manual.

Measuring rope diameter - correct

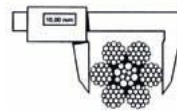

Measuring rope diameter - incorrect

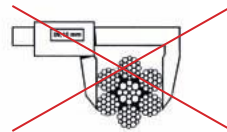

In general the diameter tolerances are $+0 / +4\%$ of nominal diameter for TEUFELBERGER ropes (if it is not different specified).

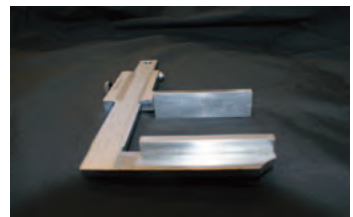

4. STORAGE, HANDLING & INSPECTION

4.4 STORAGE

Wire ropes shall be protected against humidity and weather conditions.

They should be stored in dry, well ventilated rooms at ambient temperature. Storage in damp, poorly ventilated conditions may lead to corrosion.

If ropes have to be stored in the open air, make sure to:

1. avoid that the rope is in direct contact with the ground;
2. cover the rope completely with water-proof sheets, thus preserving the original lubricant.

Allow access of air to avoid corrosion beneath the cover.

Never store wire ropes at elevated temperatures, nor expose them to dust, dirt or acids.

If wire ropes are left unused in shut-down plants, renewed cleaning and lubrication may be required when operation is resumed (see 7.2 Wire rope dressing).

CAUTION

If stored at elevated temperatures, or in damp, corrosive or dusty environments, or if contaminated by soil or chemical contact, rope properties may suffer serious harm. Stored ropes must be inspected at periodical intervals and, if necessary, re-lubricated with grease compatible with the manufacturer's instructions. Guidance on the right dressing is given in chapter 7 and/or in the crane manufacturer's maintenance instructions.

CAUTION

Incompatible dressing may render the manufacturer's lubricant ineffective, thus critically lowering the rope quality. Wire ropes withdrawn from operation and stored for later re-use require careful cleaning and lubrication prior to spooling. Store ropes under same conditions as new ropes.

4. STORAGE, HANDLING & INSPECTION

4.5 UNCOILING/UNWINDING

Wire ropes must be uncoiled or unwound by trained personnel or under supervision.

CAUTION

Incorrect handling of wire ropes may be extremely dangerous. Critical damage to ropes may seriously endanger both persons and the equipment. Wire ropes should only be handled wearing protective clothing such as safety gloves and footwear, eye protection and safety helmets.

correct



incorrect

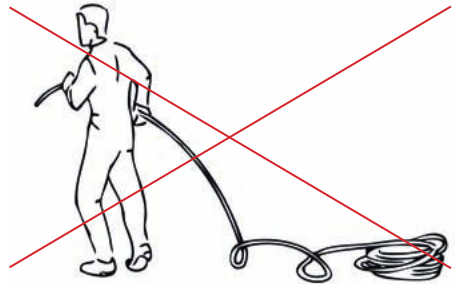

CAUTION

The failure to wear suitable protective clothing may constitute a serious health hazard and cause injuries: Skin problems resulting from excessive exposure to certain lubricants; respiratory defects from inhaling gases when cutting ropes or embedding them in sockets; eye injuries caused by sparks, wire fragments, wire and rope ends; burns produced by sparks, molten lubricants or metals; and other injuries caused by a backlash of wire and rope ends. Prior to first use, check if the wire rope corresponds to the purchase order and the rope handling system manual or OEM's (original equipment manufacturer's) instructions.

Correspondence is ascertained by measuring the rope diameter and comparing the rope construction given on the delivery note with the purchase order.

4. STORAGE, HANDLING & INSPECTION

CAUTION

The use of wire ropes not corresponding to the OEM's instructions may cause serious danger to personnel and rope conveying equipment.

Check the wire rope for defects caused by improper handling or storage.

Care must be taken when releasing the outboard end from the reel or the servings of the coil. The wire rope will tend to fly in an abrupt and violent movement. Do not stand in line with the outer end.

correct



incorrect



CAUTION

Uncontrolled release of the outboard end from the reel or uncontrolled opening of coil servings may cause injury.

Ensure that the wire rope is not damaged during installation.

To maintain rope geometry, wire ropes must be uncoiled or unwound with maximum care. The rope should not receive any twist or turn. Pulling over sharp edges or through tight radii can seriously damage the rope and must be avoided. If the rope must be drawn over fixed parts during installation, these must be covered by an adequate device such as sheaves or wooden material if necessary. The rope should never be pulled from coils sideways or over the flange of a reel to avoid turn causing serious or even irreparable damage to the rope.

4. STORAGE, HANDLING & INSPECTION

CAUTION

In the absence of any uncoiling equipment, the rope must be unrolled flat on the ground (see illustration page 27).

Uncoiling a rope from a drum also requires great care. The drum must be jacked up on a frame using a rod inserted through the drum's center hole. The rope is then uncoiled from the drum under controlled tension to avoid the formation of loops. This is achieved by applying a manual brake to the drum flange or using a special brake device. Loops formed during uncoiling may seriously damage the rope. Under load, loops contract and produce a kink which irreparably deforms the rope (see illustration below).

correct

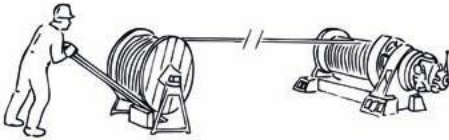

incorrect

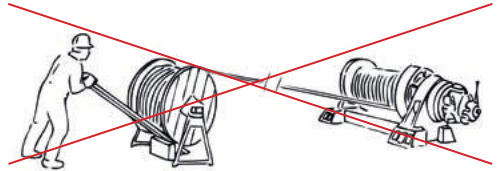

CAUTION

A kink may significantly reduce the wire rope's breaking force and cause danger to personnel and rope conveying equipment.

5. WIRE ROPE INSTALLATION

Wire ropes may only be installed by technical experts or trained persons under competent supervision.

CAUTION

Incorrect wire rope installation may be hazardous to those involved with installation and subsequent operation. Make sure that the conveying equipment is safe for rope installation and that it cannot be started accidentally. Refer to the system OEM's operating instructions. Make sure to carefully plan the sequence of rope installation. Follow the OEM's operating manual. Verify the availability of tools and auxiliary equipment required for rope installation.

Instruct installation personnel accordingly. Installation should be performed with due care and step by step under expert supervision.



Fig. 1

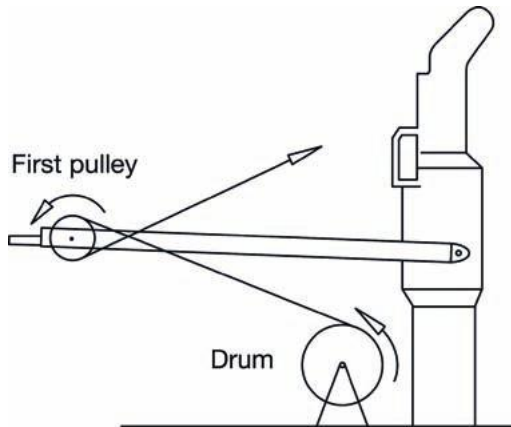

Fig. 2

During assembly, the reel should be mounted at maximum distance from the first sheave or the drum and without deflection, as deflection may cause the rope to twist (see Fig. 1).

Rotation-resistant ropes, for example, may even be damaged at fleetangles higher than 2° .

When ropes are manufactured, ropes are wound on a reel, thus acquiring a preferred bending direction. When mounting a rope, the rope should retain the same bend to avoid damaging the rope or reducing its service life (see Fig. 2).

5. WIRE ROPE INSTALLATION

5.1 FIRST TIME INSTALLATION

When fitting a new rope, turns should not be put into or taken out of the rope. If the rope is not installed by using the old rope, we recommend using a textile auxiliary rope or a thin, rotation-resistant rope. Stranded ropes must have the same direction of lay as the new rope.

Wire rope socks must be sufficiently long to prevent the ropes from slipping out.

When using an auxiliary rope to install the new rope, the rope sock must have an eyelet.

The auxiliary rope, which may be a fiber rope, must have sufficient tensile strength.

If the new rope is introduced using the old rope, a rope sock open on both ends is used.

If the installation goes over large heights, the wire rope has to be prevented from rotating.

5.2 REPLACEMENT INSTALLATION

a) If installing the new rope with the aid of an old one, one method is to fit a wire rope sock to each of the rope ends. Always ensure that the open end of the sock is securely attached to the rope by a serving or alternatively by a clip. Connect the two ends via a length of fiber rope or a small ROTATION-RESISTANT rope of adequate strength in order to avoid turn being transmitted from the old rope into the new rope.

If the old rope is used as pilot rope, make sure that no turn is transmitted to the new rope.

Do not weld together old and new ropes. Though such junction provides a certain amount of tensile strength, the rope may break when passing over sheaves, thus creating a safety risk and possibly damaging the new rope or the equipment as a whole. One way of joining the old and the new rope is by using a wire rope sock fitted over rope ends, which must be secured with tape or a clip (see illustration below).



Wire rope sock

5. WIRE ROPE INSTALLATION

WIRE ROPE SOCK SEIZING

b) Alternatively, a length of fiber or steel rope of adequate strength may be used in the system as a pilot/ messenger line.

Do not use a swivel during the installation of the rope in such a case.

Monitor the rope carefully as it is being pulled into the system and make sure that it is not obstructed by any part of the structure or mechanism which may cause the rope to come free. Failure to monitor during this operation could result in injury.

CAUTION

If ropes will be delivered with becket loop / TEUFELBERGER Pull-eye / chainlink for reeving purposes, please note that this connection can be only used while installation procedure.

5.3 CUTTING OF A ROPE

If installation requires cutting a wire rope, make sure to apply proper servings before cutting ends, a minimum of one serving to each side (see illustration below). These servings must be equal to a minimum of two rope diameters in length.

Special care has to be taken when applying servings to rotation-resistant and multi-strand ropes. Before cutting, the rope has to be secured and fixed on both sides of the cutting section so that both ends remain in the same position and do not unlay. Wire ropes are preferably cut by using an abrasive disc cutter or hydraulic rope cutter.



CAUTION

When using an abrasive disc cutter, sparks and separated wire particles as well as toxic fumes may present a health hazard.

5. WIRE ROPE INSTALLATION

5.4 REEVING

Before installing a new rope, decide whether to pull the wire rope through the entire reeving, or to wind it on the rope drum as a first step and pull it through the reeving as a second - an exceptional procedure requiring sufficient drum capacity. If one inner end of the new rope ends in a fitting (e.g. a thimble), the only possibility is to pull the free end through the reeving. When winding a rope on a plained barreled drum, subsequent turns must be coiled tightly. Sufficient rope tension facilitates the operation.

RECOMMENDATION

Avoid fleet angles higher than 2° degrees (rotation resistant ropes) and 4° degrees (non rotation resistant ropes) during installation!

5.5 CHOICE OF ROPE LAY DIRECTION IN MULTI-LAYER APPLICATION

DEFINITION OF MULTI-LAYER SPOOLING:

The ropes are spooling in multi layer application if more than one layer is spooled on the drum

HOIST ROPE

These ropes should be rotation-resistant ropes (non rotating) which are torque balanced. Due to this behavior rotation resistant rope will build a tight bottom layer, even on plain drums independent of the position of the anchor point of the drum and lay direction. (as long as the fleet angles are within the recommendations)

For hoist ropes either right hand lay or left hand lay ropes can be used on the plain barreled drum without influencing the spooling behavior.

5. WIRE ROPE INSTALLATION

LUFFING ROPE/STAY ROPE (NECK ROPE)

For this application a non-rotation resistant rope (6 strand or 8 strand) should be used. As this construction intends to rotate if loading will be initiated the usual recommendation (i.e. ISO 4308) for plain barreled drums shall be followed.

For luffing ropes/neck ropes the right hand lay should be installed on a drum with the anchor point on the left side (overwind spooling) and vice versa.

See illustration below





 <p>Start rope at right-hand flange for right-hand-lay rope</p>	<p>a) Right-hand-lay rope – underwind</p>
 <p>Start rope at left-hand flange for left-hand-lay rope</p>	<p>b) Left-hand-lay rope – underwind</p>
 <p>Start rope at left-hand flange for right-hand-lay rope</p>	<p>c) Right-hand-lay rope – overwind</p>
 <p>Start rope at right-hand flange for left-hand-lay rope</p>	<p>d) Left-hand-lay rope – overwind</p>
<p>NOTE Thumb indicates the side of the rope anchorage.</p>	

Figure C.1 — Correct method for locating the rope anchorage point on a drum

5. WIRE ROPE INSTALLATION

5.6 MULTI-LAYER SPOOLING

If multi-layer spooling is required on the equipment's winch drum, ensure that the new wire rope is under tension as it is coiled on the drum. High tension on the rope increases its radial stability (recommended tension = approx. 2,5 – 5% of MBF of rope), thus significantly reducing wear in the lower rope layers on the drum.

Loose winding may subsequently, when spooling under load, cause outer rope layers to cut into layers below, resulting in irreparable rope damage. The outer layers may even be pulled in and trapped. The rope then has to be pulled out from layers below by subsequent uncoiling. In most cases it will be sufficient to wind up the rope first, then pull it completely through the reeving (to the dead wraps) and subsequently wind it on the drum under minor back tension. Some rope systems require drum winding of the rope onto the drum under tension during initial installation. Rope tension should be as high as possible, but not more than recommended above of the minimum breaking force. Such back tension can be achieved by applying a brake to the reel as the rope is drawn off. Please note that it is necessary to order conventional reels for the described installation procedure. Cross reels are unsuitable.

Brakes or tensioning apparatus shall not be applied to the rope directly to avoid twisting or deforming the rope, causing irreparable damage.

CAUTION

Loose or uneven spooling on the drum may cause excessive wear, crushing and deformation of the rope.

For further assistance in relation to correct choice of rope lay direction in the crane system, please contact

TEUFELBERGER Seil Ges.m.b.H., T +43 7242 615-0, E wirerope@teufelberger.com

5. WIRE ROPE INSTALLATION

5.7 RECOMMENDATION FOR OPTIMAL SPOOLING OF ROPES IN MULTI-LAYER APPLICATION ON PLAIN BARRELLED DRUMS

INSTALLATION

- Make sure that you use fully compacted ropes. These ropes are more resistant against radial deformation.
- Install the ropes with proper tension and avoid loose layers (especially on the first wraps/ layer on the drum.
- Rope entrance on the drum has to be smooth as the very first rope wrap has to be very tight on the drum flange. Avoid sharp edges in this area!
- When upwinding the first turn ensure a close contact to the drum by the use of a plastic hammer in order to avoid any damages on the rope.
- If first layer is fully spooled onto the drum please check if there is any remaining gap between last wrap on the first layer and drum flange. The gap should not be larger than $\frac{1}{2}$ of the rope diameter. If gap is larger please install a shim plate according to crane manufacturers recommendation.
- Please note that the gap can vary because of the existing drum - and rope tolerances
- Additionally for boom hoist ropes please try to tighten the rope structure in the safety wrap area with the help of twisting the end of the rope at the anchor point side (instructions are available at crane manufacturer or TEUFELBERGER).
- Try to use just the number of turns that are necessary for the operation of the crane and regarding to safety wraps, follow crane manufacturer's manual and applicable regulations (API).
- Please avoid to use 1st rope layer as guidance layer because of the risk of crushing.
- Please consider a run in time for a new installed rope in order to make wire/strand settings happen follow manufacturer's regulations.
- Avoid slack rope in the system because of the risk to get loose wraps/layers with the result of crushing.
- Make sure that the rope is permanent very well lubricated which reduces friction between each wraps and layers of rope.
- In general usage of lang's lay – compared to ordinary lay - construction provide even more flexibility and crushing resistance and lead to longer lifetime and better handling of ropes.

5. WIRE ROPE INSTALLATION

5.8 RECOMMENDATION: ROPE INSTALLATION ON MULTI-LAYER DRUMS FOR LUFFING ROPES

For luffing ropes only:

Before fixing the rope at the anchor point, twist the rope around its axle into the "tight" direction before with a suitable twisting device. Make sure, that the twist does not turn back, while fixing the rope.

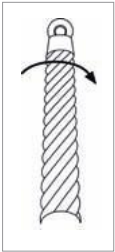

Example of a dead end:
Two different views,
but one rope

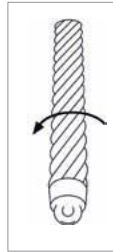

Lay Type of rope:
ordinary right

FIXING THE ROPE AT THE ANCHOR POINT OF THE DRUM:

Secure the rope at the position within the anchor point of the drum.

NOTE

One person of the team has to take care that the twist does not turn back while fixing the rope. After fixing the rope within the anchor point, the twisting device must be removed from the rope!



5. WIRE ROPE INSTALLATION

UP-WINDING UNDER TENSION

The first layer must have an adequate tension of at least 2,5 – 5% of the minimum breaking force or - for heavy operation - 10% of the rope tension of the expected load.

Proper spooling (no gap between the strands)

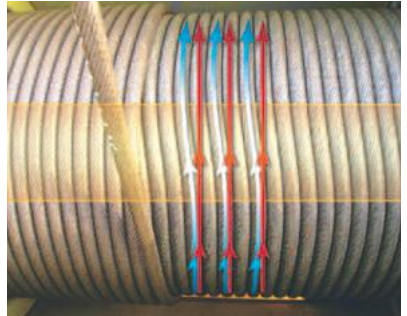

5.9 AFTER FINISHING INSTALLATION

Any limit switch, if fitted, must be checked and re-adjusted, if necessary, after the rope has been installed.

Record the following details on the Certificate after installation has been completed: type of equipment, location, plant reference number, date of installation and any re-rating information/ signature of competent person. Then safely file the Certificate.

RUNNING-IN TIME

Run in the new rope by operating the equipment slowly a number of times, preferably with a low load of approx. 10% of the working load limit (WLL), for several cycles. This permits the new rope to adjust itself gradually to working conditions.

Check that the new rope is spooling correctly on the drum and that no slack or cross laps develop. If necessary, apply as much tension as possible to ensure tight and even coiling, especially on the first layer. Ensure that the as-manufactured condition of the rope is maintained throughout the whole of the handling and installation operation.

NOTE

The rope should be in this condition before any proof test of the equipment or machinery is carried out.

6. ROPES IN OPERATION

6.1 GENERAL

Inspection should be performed acc. to the regular standards, example ISO 4309 or API 2D or other regulations applicable in the particular country.

Example: see Comparison of discard criteria ISO 4309 – API 2D

6.2 INSPECTING THE ROPE CONVEYING SYSTEM

The rope conveying system must be inspected by a competent person or trained personnel only.

The wire rope's path through the equipment should be monitored to check for any worn areas produced by friction of rope and other parts; take remedial action if necessary.

CAUTION

Failure to check the rope system may decrease rope service life and safety of operation.

CAUTION

Defects in the rope conveying system may cause serious injury to personnel. Each defect in rope pulleys or drums will damage the rope, thus shortening the rope's service life at a much faster rate than through normal wear. Careful inspection of the system is therefore required prior to installation. Before fitting the new rope, check the condition of the entire system.

6.3 SHEAVES AND DRUMS

Check the groove diameter and condition of rope sheaves, deflection sheaves and drums. Grooves in rope drums, rope and compensation pulleys must fit rope diameters. The groove diameter should never be smaller than the actual rope diameter: ideally nominal diameter +6%. The groove diameter is checked with special groove gauges (see illustration below). New wire ropes may be larger in diameter than old ropes, having thinned through use. When installing a new wire rope, it may not fit into the groove. Ropes running in narrow sheave grooves will present less endurance. For the groove base to comply with ISO 4308 and API 2D, worn grooves may need to be maintained out prior to rope installation. We recommend to change the sheave. Further the conditions have to be provided for the groovings at the drum.



Sheaves should rotate easily and the bearings must be in good condition. The sheaves must be in alignment with the rope travelling direction and should have no wobble and the sheaves should have no burrs. The drums must be checked for cracks and the rope guards and drum wedges have to be in perfect condition.

Winding drums and sheaves shall be checked periodically to ensure that all these components rotate correctly in their bearings. Stiff or worn-out sheaves or rollers cause severe abrasion of the rope.

Ensure that every sheave rotates easily. Make a visual inspection of the groove design to see if there are any changes on the surface.

6. ROPES IN OPERATION

Ineffective compensation of sheaves may give rise to unequal loading in the rope reeving. The radius at the bottom of the groove in all sheaves shall be adapted to the nominal diameter of the rope supplied (see ISO 4308, EN 12385-3 or API 2C and API 9B for worn groove radii at sheaves).

If the radius has become too large or too small, the groove should be refashioned or the sheave replaced.

Example how to figure out the actual groove diameter with groove gauges.

-> Sheave for nominal rope diameter 25.0 mm



Act. groove diameter 25.0mm



Worn-out sheave: simulated rope diameter
-> too small

26.5 mm which corresponds to +6% of the nominal rope diameter

The contour at the bottom of the grooves should be circular, and it is recommended that the groove radius, r , should be within the range of $0.525 d$ to $0.550 d$, with $0.5375 d$ as the optimum, which is equal to + 5% of the nominal rope diameter = 26.25 mm minimum. This also applies to the pitch of the drum.

6. ROPES IN OPERATION

6.4 ACTUAL ROPE DIAMETER

The actual rope diameter is usually between + 0% and + 4% of nominal diameter. Ropes that are used in multi layer spooling with several layers often require tighter tolerances in order fit closely to the pitch at the drum. For correct measuring see page 18. We recommend using calipers with wide jaws for measuring the actual diameter in order to get proper exact results.

In order to find out the lay length measurements

If actual diameter varies significant to nominal diameter and allowed diameter tolerances, there could be a external twist in the rope. In order to find out lay length, measurements can be taken.

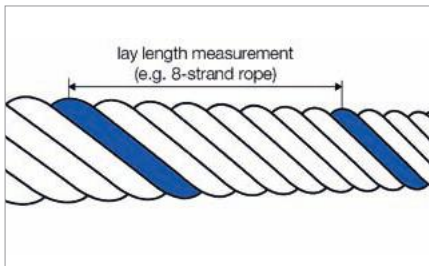

For further instructions please contact
TEUFELBERGER Seil Ges.m.b.H.

For minimum allowed actual diameter (e.g. below nominal diameter), please follow discard criteria information API 2D / ISO 4309.

6.5 END TERMINATION

Rope anchorages and suspension devices must be in perfect condition. Check if rope termination fits to the anchor point. Make sure that anchor point and fittings meets to the OEM's operating instructions.

6.6 DOCUMENTATION

The accurate records of the examiner can be used to predict the lifetime of a particular type of rope on a crane. Such information is useful for regulating maintenance procedures and also for controlling the replacement of rope stock.

6. ROPES IN OPERATION

Wire rope inspection sheet ISO 4309

Details see page 58 - 64

EXAMINATION RECORD

1) General

Customer: _____ User: _____ Location of inspection: _____ Date of inspection: _____

Reason: _____ Reference: _____

2) Application

Manufacturer: _____ Type: _____ Serial number: _____ Year of construction: _____ Kind of application: _____

3) Rope

Type of rope: _____ Construction: _____ Identnumber: _____ Art-Number: _____ Direction, type of lay: s2-(A) s3-(B) z2-(C) z3-(D)

Nominal diameter: _____ Nominal lay length: _____ Tensile Grade: _____ Quality (Zinc, un-coated,...): _____ Length: _____

Nr. History (Manufacturer, Type, ...): _____ Date fitted: _____ at working hour: _____ Date of discard: _____ at working hour: _____

Number of load bearing wires in all outer strand of the rope: _____

Permissible number of broken wires acc. to ISO 4309:2004:

6 x Ø
30 x Ø

1st End-termination: _____

2nd End-termination: _____

Area of examination	Position @ rope [m]		Actual diameter ¹⁾	Actual lay length	Visible broken wires	Abrasion of outer wires	Corrosion	Damage and Deformations	Remarks and other comments	Cumulative degree of deterioration	Picture report
	Start @ End	x1	x2	average	LL / Periodic						
		[mm]			6xØ	30xØ	Slight=20%, Medium=40%, High=60%, Very high=80%, Discard=<100%				Picture Number

Date: _____ Signature: _____

- 1) The actual diameter shall be measured with a suitable caliper fitted with jaws broad enough to cover not less than two adjacent strands. The measurements shall be taken on a straight portion of the rope, at two points and at each point at right angles. The average of these four measurements shall be recorded.
- 2) According to ISO 4309:2004 Annex B. Describe degree of deterioration as: slight, medium, high, very high, or discard.

abbreviation ISO 4309

s2
z3
s2
s3

abbreviation of rope by Tuffelsbacher

A
B
C
D

Description of lay toe

ordinary right
ordinary left
Large lay right
Large lay left



NOTE: Reference has been made to the discard criteria of ISO 4309 - Cranes - Wire Ropes-Care, i.e. maintenance, installation, examination and discard. Although this standard concerns cable and portal cable cranes, we are convinced that it is applicable for this particular application, too. Nevertheless, it is important to note that there may be other regulations or standards, which must be applied in this particular case.

6. ROPES IN OPERATION

Wire rope inspection sheet API-2D

EXAMINATION RECORD					
1) General		User: _____		Location of inspection: _____	
Customer: _____		Date of inspection: _____		Reference: _____	
Reason: _____		Reference: _____			
2) Application					
Manufacturer: _____		Type (Model-No.): _____	Serial number: _____	Date manufactured: _____	Kind of application: _____
3) Rope					
Type of rope: _____		Construction: _____	Identnumber: _____	Art.-Number: _____	Direction, type of lay: <input type="radio"/> sZ-(A) <input type="radio"/> sS-(B) <input checked="" type="radio"/> sZ-(C) <input type="radio"/> sS-(D)
Nominal diameter: _____	Nominal lay length: _____	Tensile Grade: _____	Quality (Zinc, un-coated,...): _____	Length: _____	
Ø					
Nr.:	History (Manufacturer,Type,...):	Date fitted:	at working hour:	Date of discard:	at working hour:

Wire Rope Replacement Criteria for broken wires: (API-2D / C. 5.1.3 / Page 35)

- a) Six (6) randomly distributed broken wires in one (1) lay length
 b) Three (3) broken wires in one strand within one (1) lay length

1st End-termination: _____
 2nd End-termination: _____

Area of examination	Position @ rope [m]		Actual diameter ¹⁾			Actual lay length	Visible broken wires	Abrasion of outer wires	Corrosion	Damage and Disturbances	Remarks and other comments	Cumulative degree of deterioration	Picture report	
	Start @ End	x1	x2	average	LL / Periodic	Number on a length of		Describe degree of deterioration ²⁾						Value in %
						6xØ	30xØ	Slight=20%; Medium=40%; High=60%; Very High=80%; Discard=<100%	Picture-Number					

Date: _____ Signature: _____

1) The actual diameter shall be measured with a suitable calliper fixed with jaws broad enough to cover not less than two adjacent strands. The measurements shall be taken on a straight portion of the rope, at two points and at each point at right angles. The average of these four measurements shall be recorded.
 2) According to ISO 4309:2004 / Annex B. Describe degree of deterioration as: slight; medium; high; very high; or discard

Abreviation ISO 4309	Abreviation of rope by Telefericables	Description of lay type
sE	A	ordinary right
sS	B	ordinary left
sZ	C	Langs lay right
sS	D	Langs lay left



NOTE: Except the discard criteria for broken wires, reference has been made mainly to the discard criteria of ISO 4309 - Cranes - Wire Ropes - Care, i.e. maintenance, installation, examination and discard. Although this standard concerns cable and portal cable cranes, we are convinced that it is applicable for this particular application, too. Nevertheless, it is important to note that there may be other regulations or standards (API), which must be applied in this particular case.

6. ROPES IN OPERATION

6.7 INSPECTION OF LEBUS GROOVED DRUMS FOR MULTI-LAYER SPOOLING

INFLUENCES ON THE QUALITY OF MULTI-LAYER SPOOLING

- Tolerance range of the actual rope diameter
- Number of outer strands / rope construction
- Type of rope lay (ordinary / lang's lay)
- Rope resistance against radial deformation
- Line pull
- Drum geometry (pitch, width, etc.)
- Fleet angle
- Number of wraps in one layer
- Number of layers
- Line speed

IMPORTANT:

A big factor of proper multi-layer spooling is the correct relation between actual diameter and actual drum pitch (or drum width on plain barreled drums).

RELATION OF ACTUAL DRUM PITCH TO ACTUAL ROPE-Ø

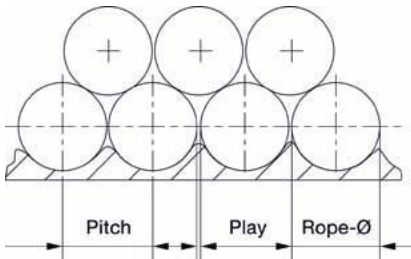

$\text{play} = \text{act. pitch} - \text{act. rope-}\varnothing =$
 $(0.005 \text{ to } 0.015) \times \text{act. rope-}\varnothing$



Recommended measuring of drum pitch.

RELATION OF ACTUAL DRUM PITCH TO ACTUAL ROPE-Ø

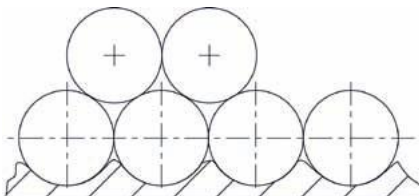

Resulting in severe wear



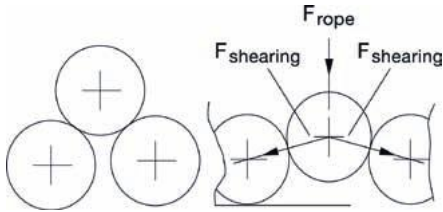

Danger of cutting in



DRUM MEASUREMENT

Measurement tools

- groove gauge
- filler gauge
- pitch cylinders
- screwdriver
- caliper
- tape measure
- ruler
- cleaner & cleaning cloth

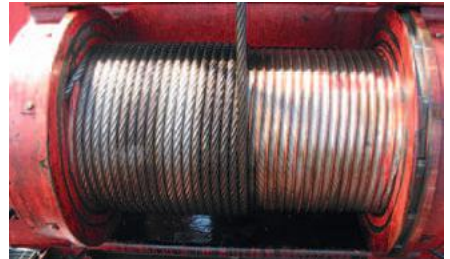

Measurement tools

6.8 TWISTING OF SHEAVE BLOCK

Some rotation may occur in the initial cycles of operation. This rotation may result in the twisting of the parts of rope forming the reeving or from the following features:

Turn induced during installation of the rope.

Turn induced by the operating arrangements of reeving.

Turn induced by the drum.

6. ROPES IN OPERATION

6.9 UNTWISTING OF HOISTING ROPE

Untwisting of the crane pulley block with a rotation-stable fixed point:

Determination of direction of twist

Bring the boom into horizontal to its lowest position and the pulley block down to its lowest position. Then determine the direction of twist of the pulley block from the crane cabin.

If the pulley block twists counter-clockwise, the rope has to be twisted clockwise at the fixed point. (Reverse if the pulley block twists clockwise.)

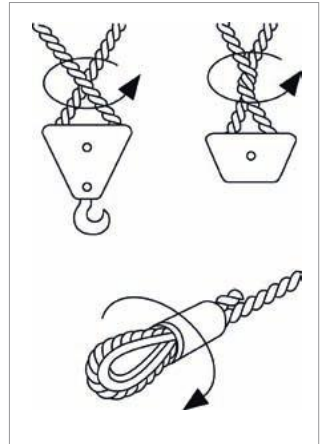

6.10 USING OF SWIVEL

Swivels may only be used with rotation-resistant wire ropes. With 6- or 8-strand ropes as well as low-rotation ropes swivels are not allowed. These types untwist under load if the ends of the ropes are not fixed. This causes high tension in the wires and therefore reduces fatigue life.

Definition:

„A steel wire rope is defined as rotation-resistant, if a free length of $L = 1000 \cdot d$ and a specific load of $S/d^2 = 0$ to 150 N/mm^2 turns 360° maximum.“

S.....load

d.....rope diameter

(Ref.: Klaus Feyrer; Drahtseile; Springer 1994; p.104, p.358)



7. WIRE ROPE MAINTENANCE (GENERAL)

Wire ropes must be maintained at regular intervals (e.g. DIN 15020/ISO 4309 or other local regulations). Ensure that the rope conveying equipment cannot be started up by unauthorized persons during maintenance operations.

7.1 CLEANING OF WIRE ROPES

Dirt must be removed from the rope before dressing.

When cleaning the rope with a cloth, fibers may get stuck on broken wires or defective parts of the rope. Dirt can be removed using a wire brush. Use protective goggles when cleaning the rope with a brush. Cable car ropes are cleaned with special cleaning devices.

7.2 WIRE ROPE LUBRICATION

Depending on operation, wire ropes must be lubricated at regular intervals.

Use a lubricant that is compatible with the manufacturer's lubricant previously applied. If using a solvent-based lubricant, it should be used sparingly because the solvent may dissolve or wash out the original lubricant. Repeated lubrication of wire ropes enhances their endurance and may reduce corrosion.

CAUTION

Solvents can dissolve the manufacturer's lubricant, causing large quantities of lubricant to accumulate on the rope surface. This presents a hazard to rope conveying equipment requiring a minimum of friction between rope and sheave.

7. WIRE ROPE MAINTENANCE (GENERAL)

If the rope cannot be dressed for operational reasons, expect it to be less durable and arrange for shorter inspection cycles.

CAUTION

Ropes not dressed at the required intervals can have a significantly shorter life span than ropes undergoing regular lubrication. Ropes are usually dressed by using a brush, cloth or the like. There are also solvent-based lubricants that can be sprayed on. Drip-feed lubricators or high-pressure lubricating machines are used in special cases. High-pressure lubricators should only be handled by qualified personnel adhering to manufacturer's instructions.

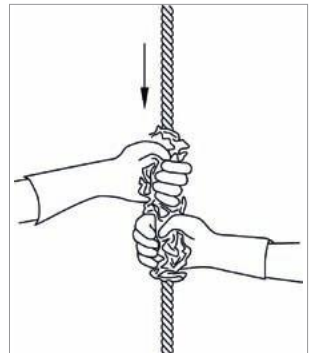
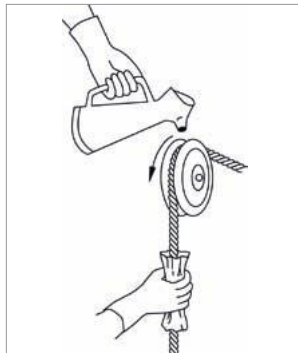
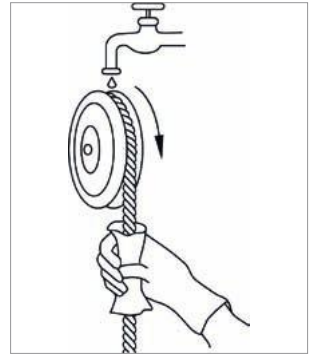
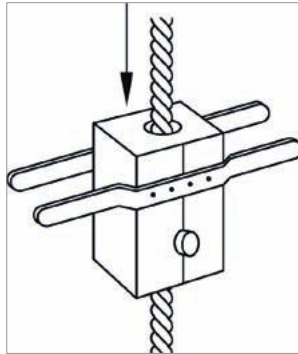

7. WIRE ROPE MAINTENANCE (GENERAL)

TEUFELBERGER ropes are greased during manufacture to reduce friction within the rope and prevent corrosion. When ropes eventually turn dry by use and grease wears off, re-lubricate to enhance durability. Unolit Oil spray was developed for this purpose.

Unolit Oil spray has been tailored to the original lubricant used during manufacture and can be applied quickly and sparingly by using the attached application device.

This special grease covers a wide temperature range between minus 40°C and plus 85°C.

TEUFELBERGER recommend re-lubricating sparingly to preserve original lubricant.

7.3 RE-LUBRICATION

If the wire rope has to be relubricated, ask the rope manufacturer which form, which oil or grease manufacturer you can use for which product. Lubricants selected for in-service dressing must be compatible with the rope manufacturer's lubricant and should be specified in the OEM's instruction manual or other documents approved by the owner of the appliance. A 'dry' rope unaffected by corrosion but subject to bend fatigue is likely to achieve only 30% of that normally attained by a 'lubricated' rope.

CORRECT LUBRICATION

For a compatibility check of the lubricant you want to use, please provide a material & safety data sheet for final approval.

Do not carry out any inspection or maintenance of the rope if the appliance controls are unattended, unless the surrounding area has been isolated, or sufficient warning signs have been posted within the immediate vicinity.

If the appliance controls are attended, the authorized person must be able to communicate effectively with the driver or controller of the appliance during the inspection process.

NOTE

Do not carry out any inspection, examination, dressing/lubrication, adjustment or any other maintenance of the rope whilst it is suspending a load, unless otherwise stated in the OEM's instruction manual or other relevant documents.

Never clean the wire rope without recognizing the potential hazards associated with working on a moving rope.

7. WIRE ROPE MAINTENANCE (GENERAL)

7.4 REMOVAL OF BROKEN WIRE ENDS

Protruding wire ends may damage neighboring wires and affect the normal travel of the wire rope. They should be removed. It is not advisable to nip ends off with pliers but to grip them, bending them backwards and forwards until the wire breaks in the valley between two strands.



7.5 SLIP AND CUT (PROCESS)

If wear mainly occurs when the rope is reeved on the Lebus drum in multiple layers, rope life may be increased by cutting off one length according to $1/3$ or $1/6$ of drum circumference.

This procedure can be repeated up to three or six times per rope.

RECOMMENDATION

In order to guarantee maximum lifetime TEUFELBERGER recommends operating always on the 1st layer, too. Safety wraps should be as less as possible, however, still in accordance with international standards (ISO, API, etc.) plus 1 wrap additionally for possible slip + cut process.

7. WIRE ROPE MAINTENANCE (GENERAL)

7.6 ADDITIONAL TROUBLESHOOTING FOR EXPERIENCED STAFF

CRUSHING OF LUFFING ROPE ON DRUM - MAINLY ON THE FIRST LAYER:

- Check the tightness of the rope of each layer and wrap
- Check how many wraps are remaining on the drum while the boom is in boom rest position (Safety wraps should be as less as possible)
- If there is on indication of rope-crushing try to shift the cross over point (crushed area) with the help of slip & cut. (1/3 of drum circumference)
- Reinstall the rope with tension. In case of the luffing rope tighten the rope structure with the help of twisting. (instructions available at TEUFELBERGER or crane manufacturer)
- Check D/d ration (recommondation 1/20)
- Check the tightness of the rope structure (test with screw driver)

IRREGULAR SPOOLING ON LUFFING AND HOIST ROPES:

- Check if the first layer is tight. (should be under tension and no gaps within the wraps)
- Check if the rope entrance is smooth on the flange and there is no gap between very 1st wrap and flange. (no sharp edge allowed)
- Check actual rope diameter which has to be between +0/+4% of nominal rope diameter
- If first rope - layer is fully spooled please check if there is any remaining gap. Gap should not be bigger than ½ of the nominal rope diameter. If gap is bigger please install a shim plate according crane manufacturers recommendation
- Check if fleet angle are in recommended range (not bigger than 2° for non rotating rope and for rotating rope not bigger than 4°)
- Check if the rope direction is suitable to the position of the anchor point especially on non rotation resistant ropes (luffing ropes).

ATTENTION

**In order to solve these problems action should be taken by experienced personal.
Or for further questions please contact a rope expert of TEUFELBERGER
(Hotline number: +43 (0) 7242 615-388)**

7. WIRE ROPE MAINTENANCE (GENERAL)

7.7 WARNINGS

Rope produced from carbon steel wires in the form shipped is not considered a health hazard. During subsequent processing (e.g. cutting, welding, grinding, cleaning) dust and fumes may be produced containing elements which may affect exposed workers.

The products used in the manufacture of steel wire ropes for lubrication and protection present minimal hazard to the user in the form shipped. The user must, however, take reasonable care to minimize skin and eye contact and also avoid breathing their vapor and mist.

After cutting, the rope cross-sections of non-preformed ropes, multi-layer ropes and parallel closed ropes must be welded, brazed or fused and tapered such that all wires and strands in the rope are completely secured.

Failure to correctly secure the rope end is likely to lead to slackness, distortions, premature removal from service and a reduction in the breaking force of the rope.

Ensure that any fittings such as clamps or fixtures are clean and undamaged before securing rope ends.

Make sure that all fittings are secure in accordance with the OEM's instruction manual or manufacturer's instructions, and take particular note of any specific safety requirements e.g. torque values (and frequency of any re-application of torque).

When terminating a rope end with a wedge socket, ensure that the rope tail cannot withdraw through the socket by securing a clamp to the tail or by following the manufacturer's instructions.

The loop back method uses a rope grip, and the loop should be lashed to the live part of rope by a soft wire serving or tape to prevent flexing of the rope in service.

The method of looping back should not be used if there is a possibility of interference of the loop with the mechanism or structure.

7. WIRE ROPE MAINTENANCE (GENERAL)

Always inspect a wire rope for wear, damage or abuse before use.

Never use a wire rope which is worn-out, damaged or abused. Never overload or shock load a wire rope.

Inform yourself: Read and understand the guidance on product safety given in this brochure; also read and understand the machinery manufacturer's handbook.

Refer to applicable directives, regulations, standards and codes concerning inspection, examination and rope removal criteria.

Protect yourself and others – the failure of a wire rope may cause serious injury or death! If the condition of the rope is not according the installation manual, please stop working immediately.

WARNING

Wire ropes will fail if worn-out, shock loaded, overloaded, misused, damaged, improperly maintained or abused.

WARNING

All recommendations and advisory services provided for rope selection by TEUFELBERGER staff is made to the best of our knowledge and is based on our long standing experience. Your own specialised knowledge gained from security analysis and your experience of use under varying conditions must not be ignored. Please note our delivery conditions.

PLEASE NOTE

This manual is created in accordance with the experience and knowledge of TEUFELBERGER. No guarantee will be accepted!

Each problem you can see below, discard criteria rules acc. to ISO 4309 and API 2D have to be considered.

CORE PROTRUSION:

Cause / action

1. Shock loading - review operating conditions
2. Too large fleet angle - control reeving
3. Change rope immediately



Source: ISO 4309

WAVINESS:

Cause / action

1. Too small groove radius - check all grooves with gauges
2. Too large fleet angle - control reeving
3. Untwisting during installation
4. Check flange of the sheaves for damage areas



Source: ISO 4309

BASKET DEFORMATION:

Cause / action

1. Untwisting during time in service - mark the rope and search for influences in the reeving
2. Shock loading - review operating conditions
3. Too small groove radius - check all grooves with gauges



Source: ISO 4309

EXTERNAL WEAR:

Cause / action

1. Too small groove radius - check all grooves with gauges
2. Sliding on edge(s) - search for abrasion on the crane
3. Check if all sheaves in the reeving are free to rotate
4. Heavy line pull - fatigue wear of a result of long time operation



8. DISCARD CRITERIA

EXTERNAL CORROSION:

Cause / action

1. Consider selection of galvanized rope
2. Review frequency, amount and type of service dressing



Source: ISO 4309

CROWN WIRE BREAKS:

Cause / action

1. Too small groove radius - check all grooves with gauges
2. Sliding on edge(s) - search for abrasion on the crane
3. Check if all sheaves in the reeving are free to rotate
4. Review operating conditions

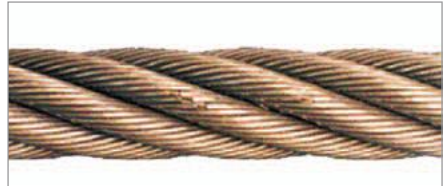

Source: ISO 4309

MECHANICAL DAMAGE:

Cause / action

1. Generally results from operating conditions
2. Check if all sheaves in the reeving are free to rotate
3. Review operating conditions
4. Check sheave guards and support rollers to ensure that the rope does not jump out of intended reeving system



ROPE CRUSHING:

Cause / action

1. not installed under tension
2. lose structure while installation
3. lose first layer / wraps on the drum



DISCARD CRITERIA FOR STEEL WIRE ROPES

NUMBER OF ALLOWABLE WIRE BREAKS TO ISO 4309

TEUFELBERGER is the specialist when it comes to manufacturing high-performance steel wire ropes for cranes, ropeways, and forestry applications. In connection with the use of our products, your safety always figures as our number one priority. Consequently, the number of wire breaks of a rope represents one of several attributes looked at when inspecting your products. Contrary to other discard criteria, the allowable number of wire breaks is design-dependent and therefore needs to be defined specifically for each rope.

NUMBER OF ALLOWABLE WIRE BREAKS TO ISO 4309 depending on:

- single-layer or multi-layer winding: for multi-layer winding, a greater number of wire breaks is allowable. See Table 3 and 4, page 60 - 61.
- ordinary lay or lang's lay design: contrary to the point-like contact in the case of an ordinary lay rope, lang's lay ropes are characterized by surface contact between the strands. This results in a reduction of wire breaks. See Table 3 and 4, page 60 - 61.
- drive mechanism group: see DIN 15020, sheet 1 - § 4.1.
- maximum number of wire breaks: 6 x rope diameter or 30 x rope diameter (the area where the critical number occurs is decisive).)
- Rope Category Number (RCN): the classification depends on the number of load-bearing wires contained in the outer strands of a rope. Filler wires do not count toward this number.

8. DISCARD CRITERIA

ISO 4309

Still valid since August 2010

INSPECTION CRITERIA:

- 1) Diameter
- 2) Length of lay
- 3) Number of broken wires
- 4) Corrosion
- 5) Kinking, crushing, cutting
- 6) Impropriety
- 7) Heavy wear
- 8) Limited areas
- 9) End connections
- 10) Lubrication

DISCARD CRITERIA:

- a) The nature and number of broken wires
- b) Localized grouping of wire breaks
- c) Valley wire breaks
- d) Wires breaks at a termination
- e) The rate of increase of wire breaks
- f) Decrease in rope diameter
- g) Local decrease in diameter
- h) The fracture of strands
- i) Corrosion (Extern, Internal, Fretting)
- j) Waviness
- k) Basket deformation
- l) Core or strand protrusion or distortion
- m) Protruding wires in loops
- n) Local increase in rope diameter
- o) Flattened portion
- p) Kink or tightened loop
- q) Bend in rope
- r) Damage due to heat or electric arcing

The individual degrees of deterioration should be assessed, and expressed as a percentage of the particular discard criteria. The cumulative degree of deterioration at any given position is determined by adding together the individual values that are recorded at that position in the rope. When the cumulative value at any position reaches 100 %, the rope should be discarded.

8. DISCARD CRITERIA

VISIBLE BROKEN WIRES:

Discard criteria for visible broken wires

	Nature of visible broken wire	Discard criteria
1	Wire breaks occurring randomly in sections of rope which run through one or more steel sheaves and spool on and off the drum when single-layer spooling or occurring at sections of rope which are coincident with cross-over zones when multi-layer spooling ^a	See Table 3 for single-layer and parallel-closed ropes and Table 4 for rotation-resistant ropes.
2	Localized grouping of wire breaks in sections of rope which do not spool on and off the drum	If grouping is concentrated in one or two neighbouring strands it might be necessary to discard the rope, even if the number is lower than the values over a length of $6d$, which are given in Tables 3 and 4.
3	Valley wire breaks ^b	Two or more wire breaks in a rope lay length (approximately equivalent to a length of $6d$)
4	Wire breaks at a termination	Two or more wire breaks
^a For typical example, see Figure B.13.		
^b For typical example, see Figure 7 and Figure B.14.		

8. DISCARD CRITERIA

Single-layer and parallel-closed ropes

Number of wire breaks, reached for exceeded, of visible broken wires occurring in single-layer and parallel-closed ropes, signalling discard of rope

Table 3

Rope category number RCN (see Annex G)	Total number of load-bearing wires in the outer layer of strands in the rope ^a <i>n</i>	Number of visible broken outer wires ^b					
		Sections of rope working in steel sheaves and/or spooling on a single-layer drum (wire breaks randomly distributed)				Sections of rope spooling on a multi-layer drum ^c	
		Classes M1 to M4 or class unknown ^d				All classes	
		Ordinary lay		Lang lay		Ordinary and Lang lay	
		Over a length of $6d^e$	Over a length of $30d^e$	Over a length of $6d^e$	Over a length of $30d^e$	Over a length of $6d^e$	Over a length of $30d^e$
01	$n \leq 50$	2	4	1	2	4	8
02	$51 \leq n \leq 75$	3	6	2	3	6	12
03	$76 \leq n \leq 100$	4	8	2	4	8	16
04	$101 \leq n \leq 120$	5	10	2	5	10	20
05	$121 \leq n \leq 140$	6	11	3	6	12	22
06	$141 \leq n \leq 160$	6	13	3	6	12	26
07	$161 \leq n \leq 180$	7	14	4	7	14	28
08	$181 \leq n \leq 200$	8	16	4	8	16	32
09	$201 \leq n \leq 220$	9	18	4	9	18	36
10	$221 \leq n \leq 240$	10	19	5	10	20	38
11	$24 \leq n \leq 260$	10	21	5	10	20	42
12	$261 \leq n \leq 280$	11	22	6	11	22	44
13	$281 \leq n \leq 300$	12	24	6	12	24	48
	$n > 300$	$0,04 \times n$	$0,08 \times n$	$0,02 \times n$	$0,04 \times n$	$0,08 \times n$	$0,16 \times n$

NOTE Ropes having outer strands of Seale construction where the number of wires in each strand is 19 or less (e.g. 6 × 19 Seale) are placed in this table two rows above that row in which the construction would normally be placed based on the number of load bearing wires in the outer layer of strands.

^a For the purposes of this International Standard, filler wires are not regarded as load-bearing wires and are not included in the values of *n*.

^b A broken wire has two ends (counted as one wire).

^c The values apply to deterioration that occurs at the cross-over zones and interference between wraps due to fleet angle effects (and not to those sections of rope which only work in sheaves and do not spool on the drum).

^d Twice the number of broken wires listed may be applied to ropes on mechanisms whose classification is known to be M5 to M8.

^e *d* = nominal diameter of rope.

8. DISCARD CRITERIA

Rotation-resistant ropes

Number of wire breaks, reached for exceeded, of visible broken wires occurring in rotation-resistant ropes, signalling discard of rope

Table 4

Rope category number RCN (see Annex G)	Number of outer strands and total number of load-bearing wires in the outer layer of strands in the rope ^a n	Number of visible broken outer wires ^b			
		Sections of rope working in steel sheaves and/or spooling on a single-layer drum (wire breaks randomly distributed)		Sections of rope spooling on a multi-layer drum ^c	
		Over a length of $6d^d$	Over a length of $30d^d$	Over a length of $6d^d$	Over a length of $30d^d$
21	4 strands $n \leq 100$	2	4	2	4
22	3 or 4 strands $n \geq 100$	2	4	4	8
	At least 11 outer strands				
23-1	$71 \leq n \leq 100$	2	4	4	8
23-2	$101 \leq n \leq 120$	3	5	5	10
23-3	$121 \leq n \leq 140$	3	5	6	11
24	$141 \leq n \leq 160$	3	6	6	13
25	$161 \leq n \leq 180$	4	7	7	14
26	$181 \leq n \leq 200$	4	8	8	16
27	$201 \leq n \leq 220$	4	9	9	18
28	$221 \leq n \leq 240$	5	10	10	19
29	$241 \leq n \leq 260$	5	10	10	21
30	$261 \leq n \leq 280$	6	11	11	22
31	$281 \leq n \leq 300$	6	12	12	24
	$n > 300$	6	12	12	24

NOTE Ropes having outer strands of Seale construction where the number of wires in each strand is 19 or less (e.g. 18 x 19 Seale –WSC) are placed in this table two rows above that row in which the construction would normally be placed based on the number of wires in the outer layer of strands.

^a For the purposes of this International Standard, filler wires are not regarded as load-bearing wires and are not included in the values of n .

^b A broken wire has two ends.

^c The values apply to deterioration that occurs at the cross-over zones and interference between wraps due to fleet angle effects (and not to those sections of rope that only work in sheaves and do not spool on the drum).

^d d = nominal diameter of rope.

8. DISCARD CRITERIA

DECREASE IN ROPE DIAMETER:

PLEASE NOTE

New ropes will normally have an actual diameter greater than the nominal diameter

Uniform decrease along the rope:

Uniform decrease in diameter signalling discard of rope - Rope spooling on a single-layer drum and/or running through a steel sheave

Rope type	Uniform decrease in diameter (expressed as % of nominal diameter)	Severity rating	
		Description	%
Single-layer rope with fibre core	Less than 6 %	—	0
	6 % and over but less than 7 %	Slight	20
	7 % and over but less than 8 %	Medium	40
	8 % and over but less than 9 %	High	60
	9 % and over but less than 10 %	Very high	80
	10 % and over	Discard	100
Single-layer rope with steel core or parallel-closed rope	Less than 3,5 %	—	0
	3,5 % and over but less than 4,5 %	Slight	20
	4,5 % and over but less than 5,5 %	Medium	40
	5,5 % and over but less than 6,5 %	High	60
	6,5 % and over but less than 7,5 %	Very high	80
	7,5 % and over	Discard	100
Rotation-resistant rope	Less than 1 %	—	0
	1 % and over but less than 2 %	Slight	20
	2 % and over but less than 3 %	Medium	40
	3 % and over but less than 4 %	High	60
	4 % and over but less than 5 %	Very high	80
	5 % and over	Discard	100

Calculation to determine actual uniform decrease and expression as percentage of nominal rope diameter

Actual uniform decrease in diameter expressed as per cent of nominal diameter is calculated using Equation (1):

$$[(d_{ref} - d_m)/d] \times 100 (\%) \quad (1)$$

where

d_{ref} is the reference diameter,

d_m is the measured diameter,

d is the nominal diameter.

8. DISCARD CRITERIA

LOCAL DECREASE

If there is an obvious local decrease in diameter, such as that caused by failure of a core or rope centre, the rope shall be discarded (for an example of a decrease associated with a sunken strand.

LOCAL INCREASE IN ROPE DIAMETER

If the rope diameter increases by 5 % or more for a rope with a steel core or 10 % or more for a rope with a fibre core during service, the reason for this shall be investigated and consideration given to discarding the rope.

FRACTURE OF STRANDS

If a complete strand fracture occurs, the rope shall be immediately discarded.

CORROSION:

Discard criteria for corrosion and intermediate severity ratings

Type of corrosion	Condition	Severity rating
External corrosion ^a	Signs of surface oxidation but can be wiped clean	Superficial – 0 %
	Wire surface rough to touch	High – 60 % ^c
	Wire surface heavily pitted and slack wires ^b	Discard – 100 %
Internal corrosion ^d	Obvious visible signs of internal corrosion – i.e. corrosion debris exuding from the valleys between the outer strands ^e	Discard – 100 %
		or if deemed practicable by the competent person, internal examination in accordance with the procedure described in Annex C
Fretting corrosion	The process of fretting involves the removal of fine particles of steel from the wires due to dry wires and strands constantly rubbing together and then oxidizing and creating internal corrosion debris, which manifests itself as a dry powder, similar to a red rouge.	Evidence of such a characteristic should be further investigated and if there is any doubt about its severity, the rope should be discarded (100 %).

^a For examples, see Figures B.11 and B.12. For an example of the progression of external corrosion in a rope, see Annex H.

^b For any other intermediate condition, an assessment should be made as to its severity rating (i.e. contribution towards the combined effect).

^c The oxidation of zinc-coated wires can result in a wire surface which is also rough to the touch, but the overall condition might not be as serious as wires which are not coated. In such cases, the inspector may consider applying a lower contribution towards the combined effect to that given above in this table.

^d For an example, see Figure B.19.

^e Assessment of internal corrosion is subjective; however, if there is any doubt about the seriousness of any internal corrosion, the rope should be discarded.

8. DISCARD CRITERIA

DEFORMATION AND DAMAGE:

Waviness

The rope shall be discarded if, under any condition, either of the following conditions exists

- a) on a straight portion of rope, which never runs through or around a sheave or spools on to the drum, the gap between a straightedge and the underside of the helix is $1/3 \cdot d$ or greater;
- b) on a portion of rope, which runs through a sheave or spools on to the drum, the gap between a straightedge and the underside of the helix is $1/10 \cdot d$ or greater.

Key

d nominal rope diameter

g gap

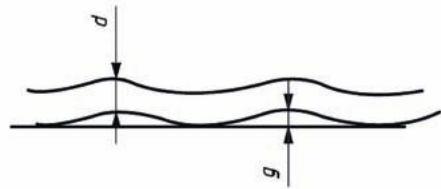

RCN OF TEUFELBERGER HIGH-PERFORMANCE WIRE ROPES

ORDINARY ROPES	Design type	Diameter range	RCN
	612 W	7 - 10	04
	PS 610 F	26 - 40	04
	QS 610 V	10 - 16	06
	EVOLUTION Q8	24 - 48	06
	QS 816 V(G)	10 - 50	09

NON-ROTATING ROPES	Design type	Diameter range	RCN
	PERFECTION TK 15	08 - 22	23-2
	EVOLUTION TK 16	08 - 30	23-1
	EVOLUTION TK 16	31 - 42	23-2
	EVOLUTION TK 17	08 - 30	23-1
	EVOLUTION TK 17	31 - 42	23-2

9. CHECKLIST FOR OPTIMAL MULTI-LAYER SPOOLING

RECOMMENDATION FOR OPTIMAL SPOOLING OF WIRE ROPES IN MULTI-LAYER APPLICATION ON PLAIN BARRELLED DRUMS

- Before starting to change the wire ropes or in case of investigation for irregular spooling, check the condition at the rope sheaves, specially the groove diameters, which must fit the rope diameter.

The groove diameter should never be smaller than the actual rope diameter.

ISO 4309(E) Chapter 4.4: For optimal performance, the effective sheave groove diameter should be larger than the nominal rope diameter by about 5 % to 10 %, and ideally, at least 1 % greater than the actual diameter of the new rope.

The groove diameter is checked with special groove gauges, available at TEUFELBERGER.

See page 39 - 40

- Rope entrance on the drum has to be smooth as the very first rope wrap has to be very tight on the drum flange. Avoid sharp edges in this area. Use grinder carefully.

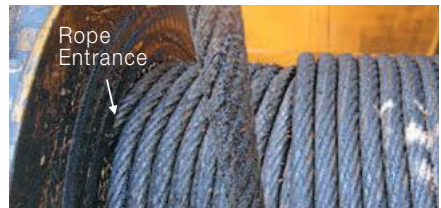

- **For luffing ropes (luffing) only:**

Before fixing the rope at the anchor point, twist the rope around it's axle into the "tight" direction before with a suitable twisting device. Make sure, that the twist does not turn back, while fixing the rope. **See page 36**

- Install the rope with proper tension and avoid loose wraps (especially at the first layer on the drum)! **See page 28**
- The first layer must have an adequate tension of at least 2,5 – 5% of the minimum breaking force.
- When upwinding the first layer, ensure a close contact to the drum's flange by the use of a non-steel hammer (copper, brass or plastic in order to avoid damages on the rope). Avoid any kind of gaps between rope wraps!

9. CHECKLIST FOR OPTIMAL MULTI-LAYER SPOOLING

- When first layer is fully spooled onto the drum, please check next to the rope entrance, if there is any remaining gap between last wrap and drum flange. The gap should not be larger than half of the rope diameter. If gap is larger, than half of the rope diameter, please install a shim-plate to close that distance. If gap is smaller than half of the rope diameter, install shim-plate only in case of spooling problems. Take under consideration, that the rope diameter will decrease during operation! Calculation of rough shim-plate size can be done by TEUFELBERGER.

The usage of of shim-plate will influence the fleet-angle (fleet angle gets reduced)!

- Please note, that the gap can vary because of the existing drum - and rope tolerances. So tack the shim-plates only instead solid welding.
- Please avoid to use the 1st layer just as guidance layer because of the risk of crushing. If necessary to do so unspool every 100 working hours until the safety-wraps and respool under tension as mentioned above.

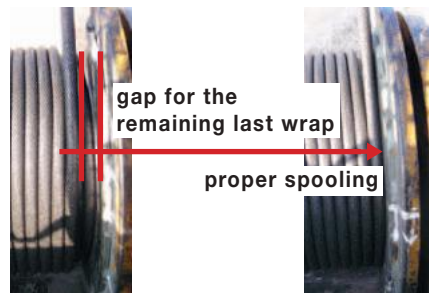
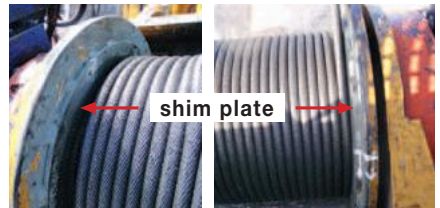
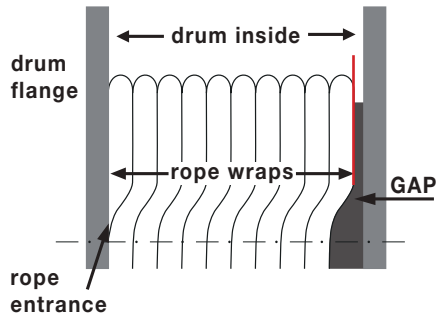

9. CHECKLIST FOR OPTIMAL MULTI-LAYER SPOOLING

- If the last wrap at any layer does not fit the whole way all around the drum because of a narration of the gap, the rope will configure a hill to rise above this narration, which causes distractions at the next layer's spooling.

Grind-off the drum's wall at the partially location of the narration.

Make sure, not to injure the wire rope's surface with the grinder or milling tool.

Cover the surface of the wire at the drum in order to avoid pollution by the grinding or milling chips.

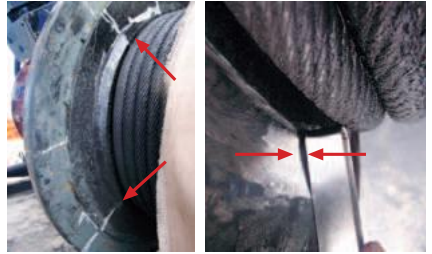

- If the desing of the crane generates too small fleet-angles at the drum in direction to the first sheave, the rope may climb up the drum's wall before it collapses upon itself into an unsystematic configuration with gaps between the wraps, - the basement for irregular spooling of the next layer.

A rope-kicker will support the wire-rope finding it's way into the valley of the prior layer right in time instead climbing up the drum's wall.



- Please consider a run in time for a new installed rope in order to make wires and strands settings happen.
Follow manufacturer's regulations.
- Avoid slack rope in the system because of the risk to get loose wraps and layers with the result of crushing.
- Make sure that the rope is permanent very well lubricated, which reduces friction between each wraps and layers of rope.
- For correct inspection adequat measuring tools are required. TEUFELBERGER offers all special groove gauges, filler gauges, wide jaws vernier calipers to ensure proper wire-rope diameter measurement on request.



YOUR BENEFIT WITH TEUFELBERGER:

EXPERTISE

Our special steel wire ropes are designed for fulfilling the requirements of your application in an optimal way.

HIGHEST QUALITY

Only high-strength material and state-of-the-art production processes are used for our products.

SERVICE AROUND THE CLOCK

Our 24-hour hotline and top service team ensure that our experts are available within the shortest time possible wherever required. 24-hour hotline: +43 (0) 7242-615-388

EXPERT CONSULTANCY

TEUFELBERGER's network of consultants ensures that expert support is close to you. Our staff is especially trained for your application which translates into cooperative development of the most useful answer to any problems which may occur.

DELIVERY RELIABILITY

TEUFELBERGER's management of orders ensures optimal processing in production and logistics.

RESEARCH AND DEVELOPMENT

Our R&D department provides permanent product improvement in terms of safety, reliability and service life.

TEUFELBERGER Seil Ges.m.b.H.
Böhmerwaldstraße 20
4600 Wels, Austria
T +43 7242 615-0
F +43 7242 60501
E wirerope@teufelberger.com

www.teufelberger.com



TOGETHER IN MOTION